

Universal Current Meter **C 31**

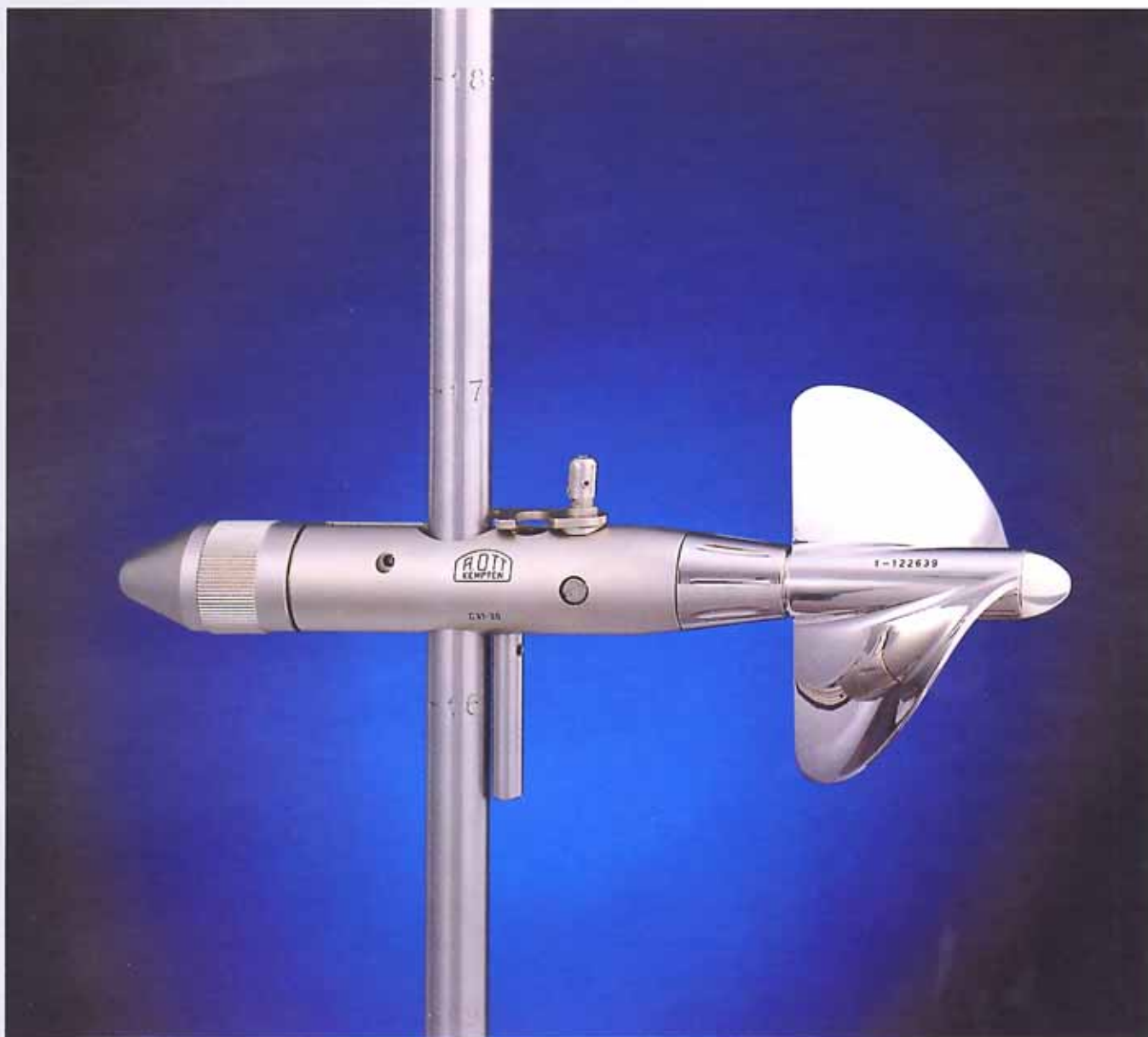

- For efficiency tests of power station turbines (Cross brace).
- For calibration and cyclical control of stream-, flow- and discharge measuring devices (Venturi, MID, ...)
- For measuring flow velocities from 0,025 m/sec. to 10 m/sec.
- Universal application on different fixing devices for use on rod or as cable-suspended meter equipment.
- The reliable instrument approved by many years practical experience under hard conditions - world-wide.

C 31 – THE ORIGINAL

- Best quality money can buy -

● Application

The C 31 Universal Current Meter is a measuring instrument to determine the flow velocity of water in open canals, rivulets, rivers, and the sea, as well as in pressure pipes.

Of rugged design and made of high-quality materials, the current meter can be used even under extreme conditions

The reliable instrument approved by many years' practical experience under hard conditions - world-wide.

For measuring flow velocities from 0,025 m/sec. to 10 m/sec.

Universal application on different fixing devices for use on rod or as cable-suspended meter equipment.



● Function

The meter propeller gets turned by the flow. A magnet turning with the propeller actuates, once per revolution, the built-in Reed contact which is watertight under pressure. The pulse sequence is nearly proportional to water velocity in the measuring point.

The exact relation between the number of propeller revolutions per second and the water velocity is determined by the equation

$$v = k \cdot n + \Delta$$

n = propeller revolution per second.

k = hydraulic pitch (m), determined by test runs in the modern rating tank

Δ = meter constant (m/sec.), determined by test runs in the modern rating tank

Since among current meters there are mechanical differences in the propellers as well as in the bearings, constants **k** and **Δ** are found by specific tests in our own rating tank (**Certificate of calibration BARGO**)

If desired, the calibration equation (relation between **n** and **v**) can also be supplied with fully calculated value and compiled in a table (**Velocity table BAREL**)

For more particulars regarding the calibration of current meters, see folder HLE 120/14

If the requirements of accuracy are not so high it is also possible to supply an average equation for the plastic propellers, which is established on the base of several individual calibration equations.



Measuring Range

Depending on the pitch of the propeller chosen, the current meter can be used for different velocity measuring ranges. In case of oblique water currents it is possible to measure

the component of the flow within an angular range which depends on the type of propeller (see table).

Propeller no. engraved.	Propeller size	Max. water velocity* (m/sec.)	Starting speed (m/sec.)	Range of Component effect	Material
1	125 mm dia.; 0,25 m pitch	5,0	0,025	5°	Brass
1	125 mm dia.; 0,25 m pitch	5,0	0,035	5°	Plastic
2	125 mm dia.; 0,50 m pitch	6,0	0,040	5°	Brass
2	125 mm dia.; 0,50 m pitch	6,0	0,060	5°	Plastic
3	125 mm dia.; 1,00 m pitch	10,0	0,055	5°	Brass
4	80 mm dia.; 0,125 m pitch	3,0	0,040	5°	Brass
A	100 mm dia.; 0,125 m pitch	2,5	0,030	45°	Brass
R	100 mm dia.; 0,25 m pitch	5,0	0,035	15°	Aluminium

* This max. velocity can only be measured by means of the Z 215 counter set which has a counting rate of up to 20 revolutions per second

Possibilities of Application

Current meter on Rod

For measurements in small rivulets and low-level waters with slow flowing speed the C 31 current meter is used in combination with a rod. The two standard methods of fixing the current meter to the rod are the following:

Direct fixing on the rod 20 mm dia.

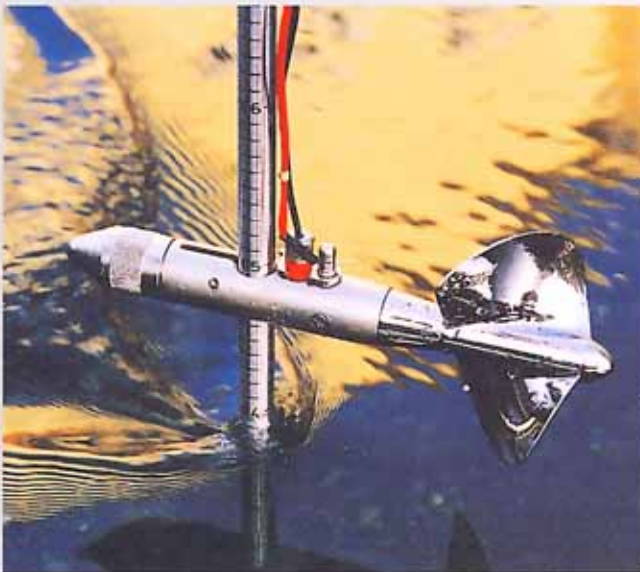

Fig. 1: C 31 current meter on rod 20 mm dia.



Fig. 2: Instrument case for a current meter used on rod

Fixing on rod, using the relocating device HERES

The use of the relocating device offers the advantage that the current meter can be positioned along the vertical in the measuring point without taking the equipment out of the water.



Fig. 3: C 31 current meter on rod 20 mm dia. with relocating device HERES.

● Possibilities of Equipment Combinations with Current Meter on Rod

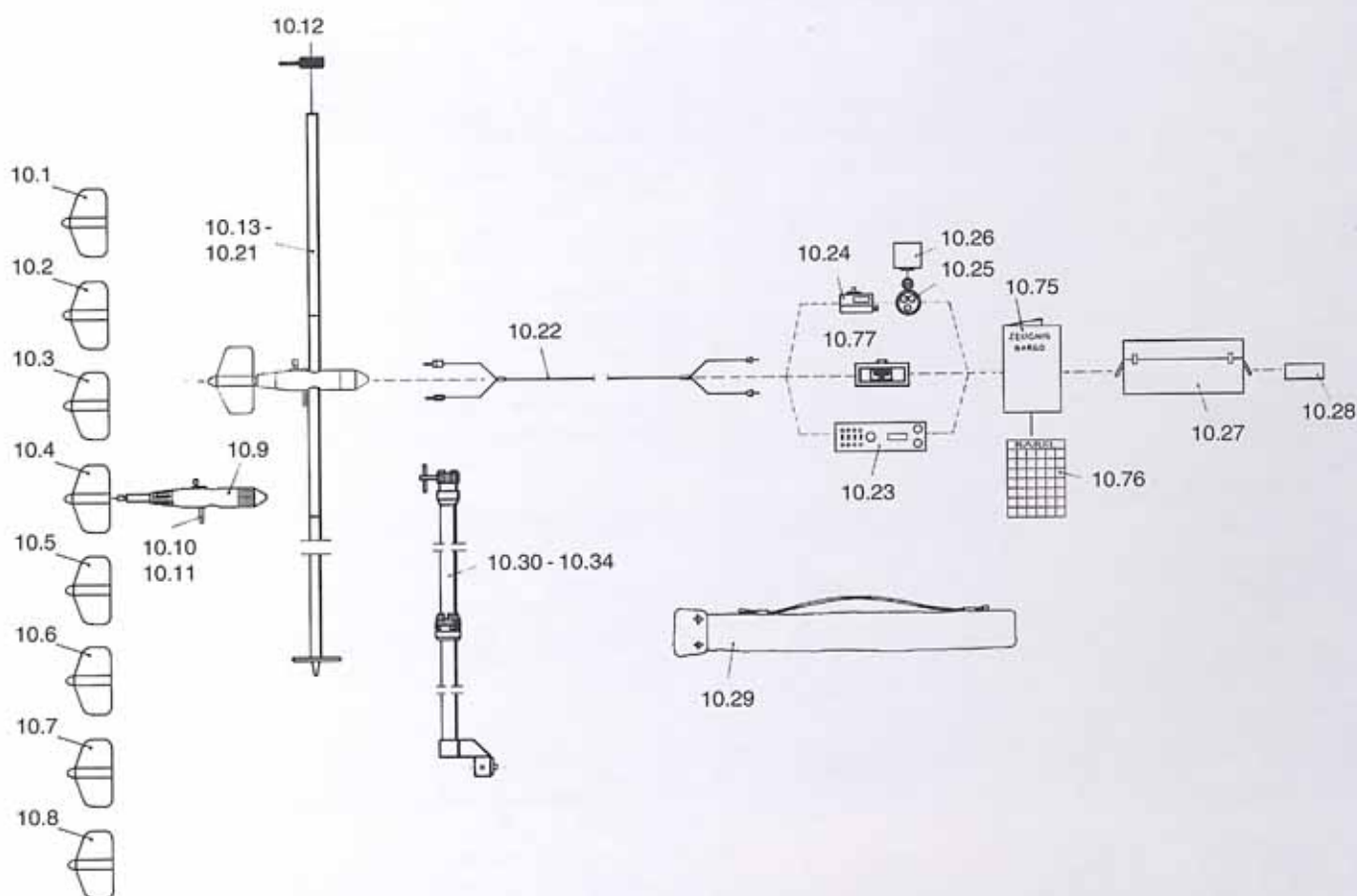

Pos. No.	Designation	Ident No.	Pos. No.	Designation	Ident No.
1	Propeller No. 4, 80 mm dia.; 0,125 m pitch	10.1		Rod 20 mm dia. with base plate and point cm-graduation	
2	Propeller No. 1, 125 mm dia.; 0,25 m pitch	10.2		Rod 3 m, 3 sections	10.18
3	Propeller No. 2, 125 mm dia.; 0,50 m pitch	10.3		Rod 4 m, 4 sections	10.19
4	Propeller No. 3, 125 mm dia.; 1,00 m pitch	10.4		Rod 5 m, 5 sections	10.20
5	Component propeller A 100 mm dia.; 0,125 m pitch	10.5		Rod 6 m, 6 sections	10.21
6	Component propeller R 100 mm dia.; 0,25 m pitch	10.6	14	Connecting cable from C 31 to counter	10.22
7	Plastic propeller No. 1; 125 mm dia.; 0,25 m pitch	10.7	15	Z 215 counter	10.23
8	Plastic propeller No. 2; 125 mm dia.; 0,50 m pitch	10.8	15.1	Z 30 counter	10.77
9	C 31 Meter body	10.9	16	Z 21 counter	10.24
10	Ground pin short (for propeller 80 mm dia.)	10.10	17	Stop watch	10.25
11	Ground pin long (for propeller 125 mm dia.)	10.11	18	Case for stop watch	10.26
12	Direction pointer (if wanted)	10.12	19	Certificate of Calibration BARGO	10.75
13	Rod 20 mm dia., with base plate and point dm-graduation		20	Velocity table BAREL (if wanted)	10.76
	Rod 3 m, 6 sections	10.13	21	Instrument case 17.601	10.27
	Rod 3 m, 3 sections	10.14	22	Tools	10.28
	Rod 4 m, 4 sections	10.15	23	Canvas bag (for rods and HERES)	10.29
	Rod 5 m, 5 sections	10.16	24	Relocating device HERES	
	Rod 6 m, 6 sections	10.17		2 m, 2 sections	10.30
				2 m, 4 sections	10.31
				3 m, 3 sections	10.32
				4 m, 4 sections	10.33
				5 m, 5 sections	10.34

● Cable-suspended Current meter

For measurements in deep waters and at higher flowing speeds the OTT C 31 current meter is used as cable-suspended equipment.

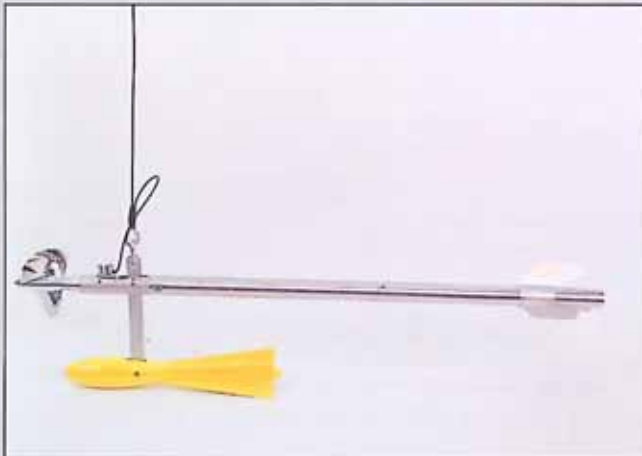

Fig. 4: Cable-suspended current meter with sinker

Two types of sinker can be supplied: 5 kg and 10 kg. The sinkers cannot be equipped with a ground-feeler. In special cases it is possible to carry out measurements without the aid of a winch.



Fig. 5: Instrument case for cable-suspended meter equipment with sinker.

Fig. 8: Instrument case for C 31 cable-suspended meter equipment with middle piece 25 kg, 50 kg or 100 kg.

For more details on our winches, as well as further facilities for integration measurements, see folder 15.470.000.P.E

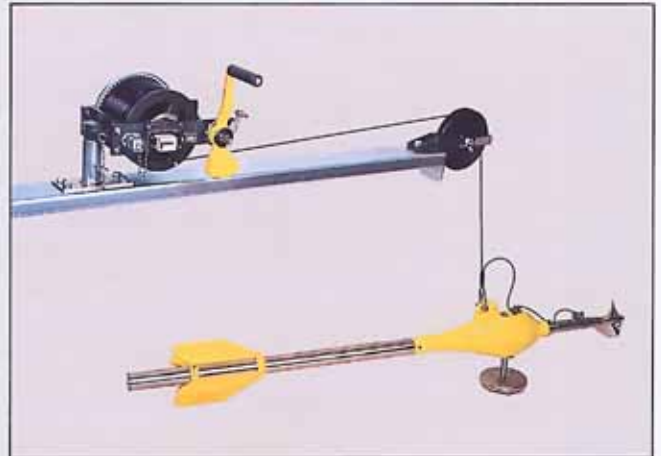

Fig. 6: Cable-suspended meter with jib, 25 kg single-drum winch, Z 215 counter set and 25 kg middle piece.

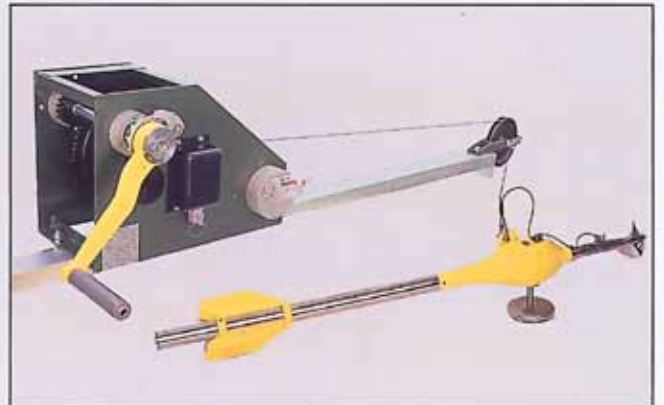

Fig. 7: Cable-suspended current meter with jib, 100 kg single-drum winch, Z 215 counter set and 50 kg middle piece .

Three types of middle piece can be supplied: 25 kg, 50 kg and 100 kg. All the middle pieces are generally equipped with an electrical ground-feeler.

For measurements with middle pieces always a winch or cable-way installation corresponding to the weight of the outfit is required.



● Combinaton-possibilities of Cable-suspended C31 Current meters

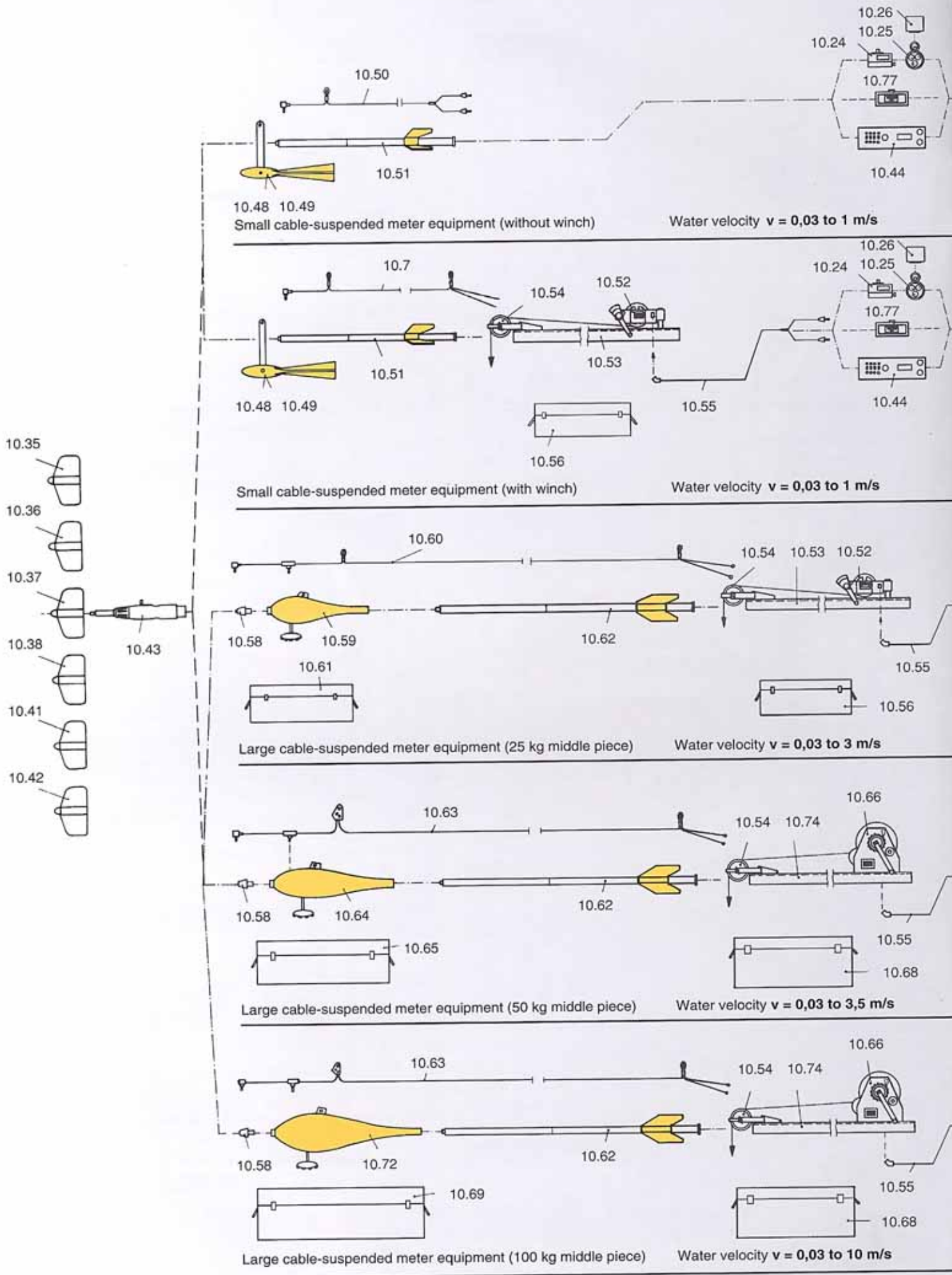

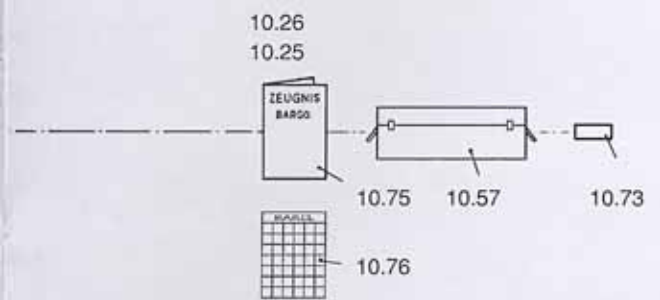

Water depth*

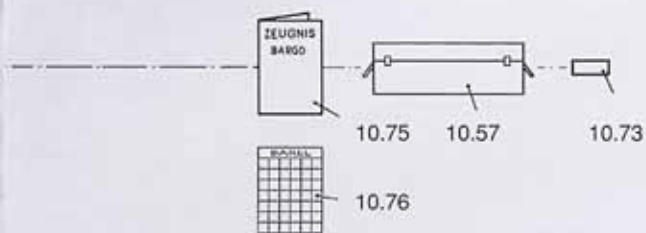

Water depth*

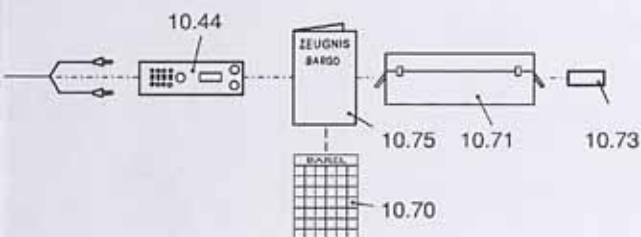

Water depth*

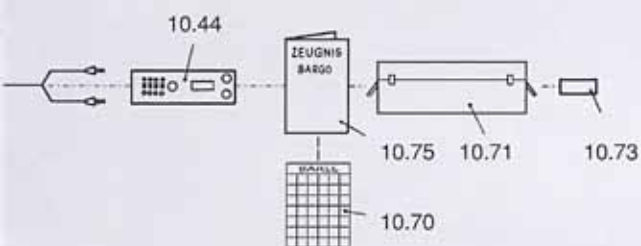

Water depth*

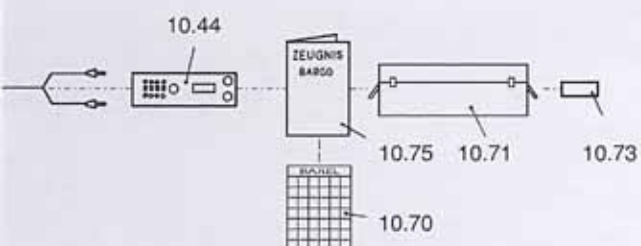

Water depth*

Pos. No.	Designation	Ident No.
1	Propeller No. 4, 80 mm dia; 0,125 m pitch	10.35
2	Propeller No. 1, 125 mm dia; 0,25 m pitch	10.36
3	Propeller No. 2, 125 mm dia; 0,50 m pitch	10.37
4	Propeller No. 3, 125 mm dia; 1,00 m pitch	10.38
7	Plastic propeller No. 1; 125 mm dia; 0,25 m pitch	10.41
8	Plastic propeller No. 2; 125 mm dia; 0,50 m pitch	10.42
9	C 31 meter body	10.43
15	Z 215 counter	10.44
15.1	Z 30 counter	10.77
16	Z 21counter	10.45
17	Stop watch	10.46
18	Case for stop watch	10.47
19	Certificate of calibration BARGO (ea. propeller 1 x)	10.75
20	Velocity table BAREL (if wanted)	10.76
25	Sinker 5 kg	10.48
26	Sinker 10 kg	10.49
27	Connecting cable 111/113 - C31 to counter	10.50
28	Stabilizer piece 0,8 m - for sinker	10.51
29	Single drum winch 25 kg	10.52
30	Jib for single drum winch 25 kg	10.53
31	Jib pulley	10.54
32	Connecting cable 111/200 from winch to counter	10.55
33	Carrying-case for 25 kg winch	10.56
34	Instrument-case 17.602	10.57
35	Intermediate piece for middle piece connection	10.58
36	Middle piece 25 kg	10.59
37	Connecting cable 111/456 - from current meter to winch	10.60
38	Carrying case for middle piece 25 kg	10.61
39	Stabilizer tail piece; 1,4 m long	10.62
40	Connecting cable 111/454 - from C 31to winch	10.63
41	Middle piece 50 kg	10.64
42	Carrying case for middle piece 50 kg	10.65
43	Single drum winch 100 kg	10.66
45	Carrying case for single drum winch 100 kg	10.68
46	Carrying case for middle piece 100 kg	10.69
48	Connecting cable 111/410 - from C 31 to winch	10.70
49	Instrument case 17.603 - f. cable suspended equipment	10.71
50	Middle piece 100 kg	10.72
51	Tools	10.73
52	Jib for single drum winch 100 kg	10.74

* see overleaf

● Extra Equipment

For other fields of application (e.g. installation in pressure pipes with cross brace or Dufor device as per VDI/VDE rule 2640, part 2) as well as for other types of fixing methods (e.g. special-section rods, sliding meter-attachments), and integration measurements a great number of special devices are available on request.

- * The maximum water depth for gauging depends on the water velocity and the permissible error in depth. The depth error can be corrected according to the following formula

$$x + y = 0,15 \tan \varphi (h + 3r)$$

x = correction in length for the part of cable below water surface

y = correction in length for the part of cable above water surface

φ = inclination of cables against the vertical

h = water depth up to gauging point

r = height of pulley above water surface

● Dimensional Drawing

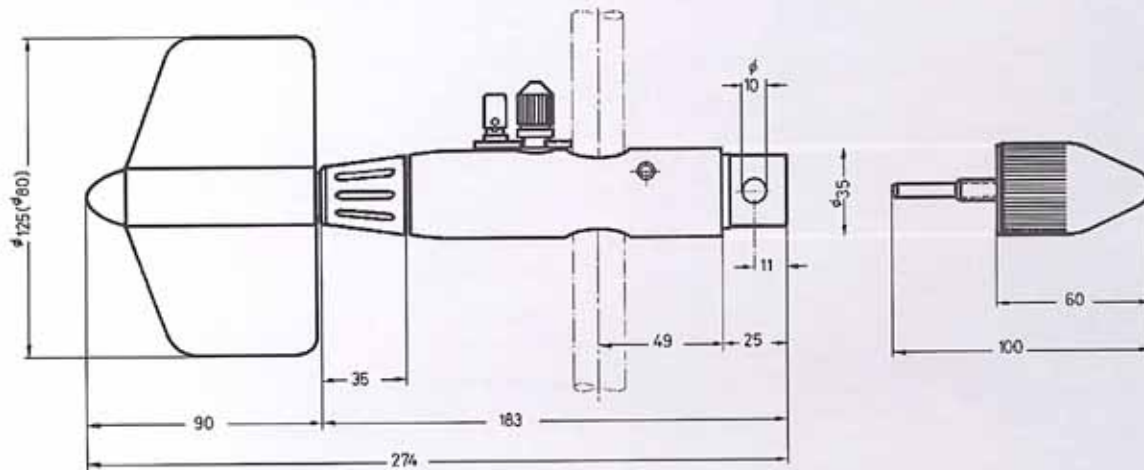

C 31 Cable suspended current meter on gas spring tensioned cable-way.



Measuring-Van with OTT- 100 kg Double drum winch and C 31 current meter.



C 31 with 25 kg Single-drum winch and movable Trolley for the measurement e.g. from a bridge.

Small design details may be changed without notice.

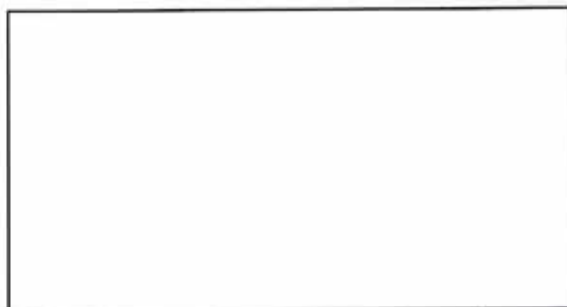

Delivery program, e.g.:

Water Level Recorders
Winches, Cable ways
Pressure Probes
Shaft Encoders
Data Loggers, Smart Sens.
Data Remote Transmission

Please ask for price list

